

Technical data sheet



Product features

Chilled display unit GN 3-1/1 bottom cover, upwards opening, Hemlock

Model	SAP Code	00012128
--------------	-----------------	----------



- Buffet type: PLATINUM - dynamically cooled showcase
- Device properties: Chilled
- Number of GN / EN: 3
- GN / EN size in device: GN 1/1
- GN device depth: 200
- Minimum device temperature [°C]: 4
- Maximum device temperature [°C]: 8
- Opening of device: Flip up

SAP Code	00012128	Loading	230 V / 1N - 50 Hz
Net Width [mm]	1169	Number of GN / EN	3
Net Depth [mm]	760	GN / EN size in device	GN 1/1
Net Height [mm]	1688	GN device depth	200
Net Weight [kg]	213.00	Minimum device temperature [°C]	4
Power electric [kW]	0.247	Maximum device temperature [°C]	8

Technical data sheet



Technical drawing

Chilled display unit GN 3-1/1 bottom cover, upwards opening, Hemlock

Model

SAP Code

00012128

A= ELECTRICAL CONNECTION
 D= WATER DISCHARGE Ø16
 E= GAS CONNECTION Ø8 Ø10
 F= WATER BOX

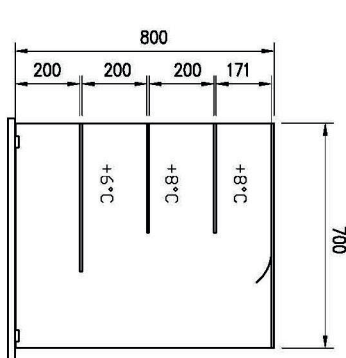
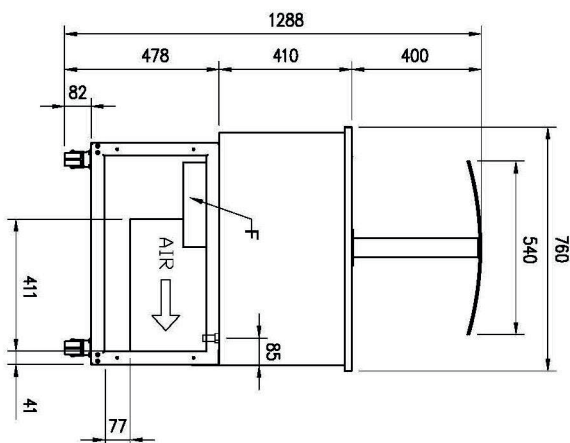
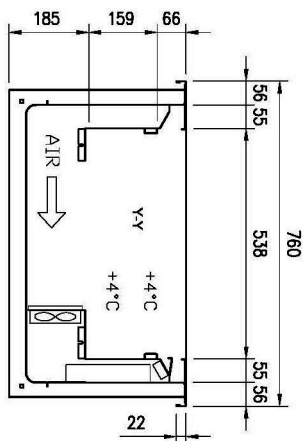
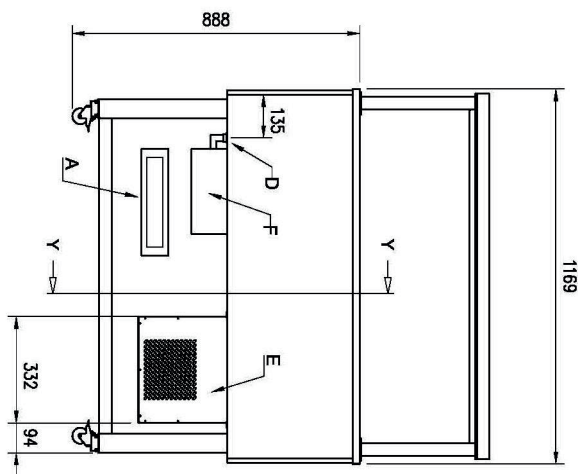
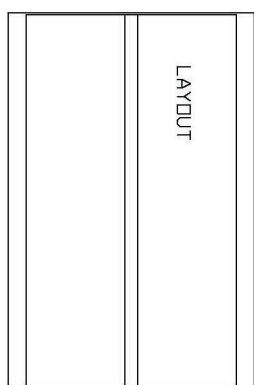

PLATINUM

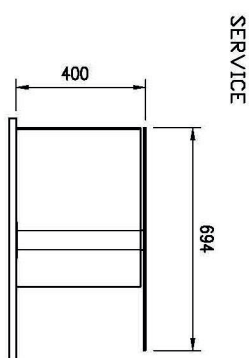

SERVICE

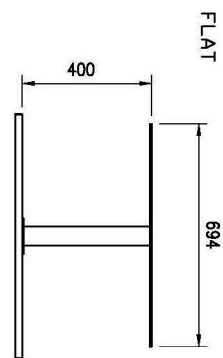

FLAT

Technical data sheet



Product benefits

Chilled display unit GN 3-1/1 bottom cover, upwards opening, Hemlock

Model

SAP Code

00012128

1

Dynamic cooling

constant temperature in all places of the refrigerated space

- greater hygienic safety of chilled food

2

LED lighting

minimal energy consumption

- economical lighting
- attractive appearance

3

Surface height regulation

a large range of the height of the bottom surface of the display case

- greater variability of product storage
- space saving

4

Braked travel wheels

easy handling

- the possibility to easily move the display case during operation as required

Technical data sheet



Technical parameters

Chilled display unit GN 3-1/1 bottom cover, upwards opening, Hemlock

Model	SAP Code	00012128
--------------	-----------------	----------

1. SAP Code:

00012128

2. Net Width [mm]:

1169

3. Net Depth [mm]:

760

4. Net Height [mm]:

1688

5. Net Weight [kg]:

213.00

6. Gross Width [mm]:

1233

7. Gross depth [mm]:

860

8. Gross Height [mm]:

1830

9. Gross Weight [kg]:

231.10

10. Device type:

Electric unit

11. Buffet type:

PLATINUM - dynamically cooled showcase

12. Device properties:

Chilled

13. Device color:

Hemlock

14. Power electric [kW]:

0.247

15. Loading:

230 V / 1N - 50 Hz

16. Number of GN / EN:

3

17. GN / EN size in device:

GN 1/1

18. GN device depth:

200

19. Minimum device temperature [°C]:

4

20. Maximum device temperature [°C]:

8

21. Opening of device:

Flip up